

**Introduction to Metal Clad PCB's**

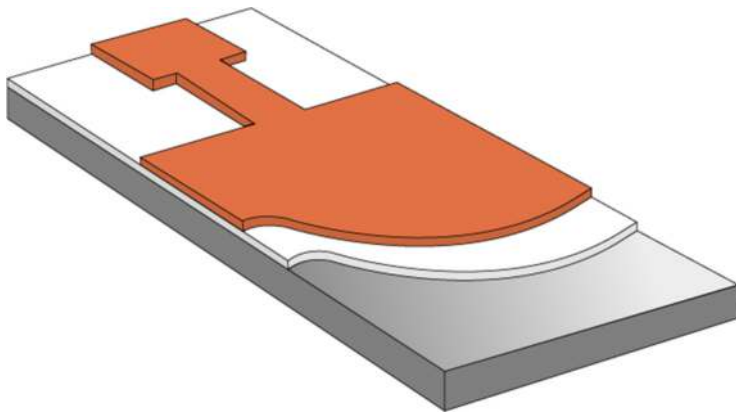

MCPCB's (MPCB's, IMS) technology was initially designed in the 60's for high power applications. Since then it has been used widely in LED's where the benefits of reduced junction temperatures have been realised.

With the boom of the LED lighting industry in the last 10 years, the demand for metal PCB's has risen dramatically.

Metal circuit technology is now being used in all sorts of applications ranging from industrial to automotive.

With this we have seen an influx of material providers influencing the market with new technology. From the 2-3 material providers years ago to the many we see on the market today.

**The structure of Metal clad PCB's?**

The material used to fabricate metal circuit boards is made of 3 parts; The base layer, the dielectric, and the copper foil -

**The Copper foil:**

This is the top copper layer of the material that will eventually be processed into the electrical conductors as per conventional PCB's. Generally 1oz-4oz but can be greater.

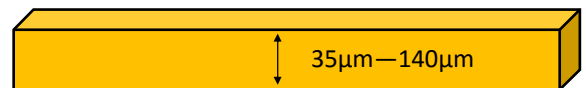

**The Dielectric:**

This is the key part. This is the substance that both electrically isolates the Aluminium base layer from the copper foil, but also allows for rapid heat transfer between the two.

It ensures that the heat generated in the components is dispersed to the heat sink as quickly as possible and determines the materials thermal properties.

This is the ingredient of the substrate that sets apart a world class material from the cheap alternatives on the market.

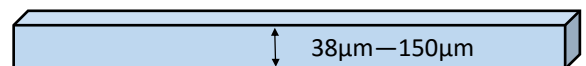

**The Base Layer:**

In the vast majority of cases the base layer is aluminium, generally 1mm-3.2mm thick (most commonly 1.6mm). Aluminium is a very efficient conductor of heat and as such is perfect for applications involving rapid heat transfer.

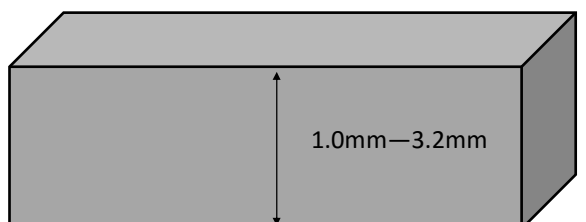

## The advantage of Metal Clad technology

The advantage of using metal clad material for PCB production as opposed to more traditional materials such as FR4 and CEM is simply to do with the efficient removal of heat.

When current is passed through any electrical system there will be the unwanted side effect of some of the electrical energy being converted into heat. With certain applications this can be insignificant, but with applications such as LED lighting, and high power products the effects can be costly when stagnant heat builds up.

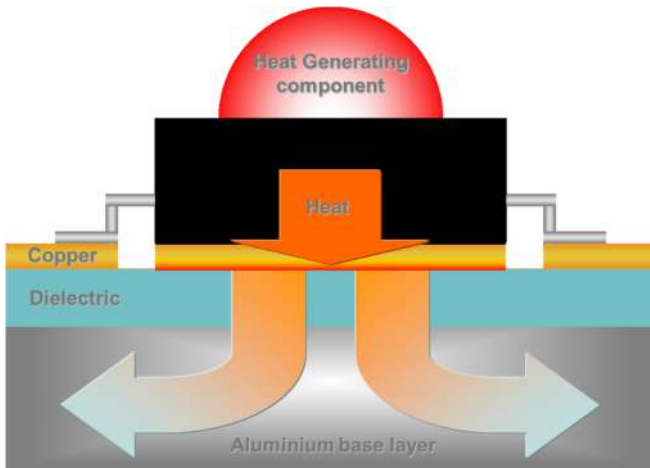

High failure rate, decreased performance and low life-span are just a few examples of side effects caused by high junction temperature. Not attributes you want customers to associate with your product, or more importantly with your reputation in the industry.

FR4 has a very low thermal conductivity (around 0.25W/m-K) and because of this; the heat generated from the components is inefficiently transferred through the circuit board to the heat sink where it is dissipated. You can have the biggest heat sink in the world but it will be insignificant if the board material acts as a thermal insulator (thermal shield) between the heat source and the heat sink.

This is where the Dielectric in metal clad materials comes into play. As opposed to FR4, dielectrics have a high thermal conductivity—generally ranging from 1W/m-K to 9W/m-K, however some specialist materials can be even higher performing.

This, coupled with the very high thermal conductivity of the aluminium base (150W/m-K) allows the heat to travel much faster from source to sink.

---

## Dielectric –Top Secret Recipe

As mentioned — the dielectric is the key factor when differentiating between the base materials used in the production of MPCB's. It is the fundamental layer that determines the thermal properties of a substrate, and the subsequent reliability of the end product.

Dielectrics can be constructed from a range of materials—most commonly using one of the following bases-

- Polymer
- Ceramic
- Epoxy
- Boron Nitride
- Or a combination of the above

The exact composition of dielectrics is not generally published for all to see due to product protection reasons.

The fundamental thermal property that manufacturers want from their thermal substrate is a low thermal impedance.

For this, they need their dielectric to have a very good thermal conductivity. This, coupled with a thin distribution over the aluminium base layer will achieve a low thermal impedance.

However, there are pitfalls with making the dielectric layer too thin. Generally speaking, the thinner the dielectric, the lower the breakdown voltage of the substrate.

Manufacturers therefore have to get the balance just right to suit certain markets—be it;

- LED applications
- High power
- Automotive
- And others



# Thermal Properties Explained

## Thermal Conductivity:

- This is a measurement of the ability of a substance to conduct heat, Measured in W/mK (Watts per metre Kelvin).
- It is a material property, meaning that it does not change when the dimensions of the material change, as long as it is made up uniformly.
- For example: the thermal conductivity of a cm<sup>3</sup> of gold is exactly the same as the thermal conductivity of a 100m<sup>3</sup> of gold.
- Generally obtained in the industry using one of two tests, either the D-5470 test, or the E-1461 test.
- The D-5470 test measures the thermal impedance in Ccm<sup>2</sup>/W (Celsius, centimetres squared per watt) of the sample and gets a value of the thermal conductivity through the relation:

### **Thermal Conductivity = Thickness / Thermal Impedance**

- The E-1461 test measures the thermal diffusivity and the specific heat capacity of the sample , and gets a value of the thermal conductivity through the relation:

### **Thermal Conductivity = Thermal Diffusivity \* Specific Heat Capacity \* Density**

## Thermal Resistance:

- Thermal resistance (measured in Celsius per watt) is basically the same as the thermal impedance. The difference is that it takes into account the area of the sample as well as the thickness and conductivity.
- This means that it is a very specific, object property. Changing either the thickness or the area of the material will change the associated value of the thermal resistance.
- For example: the thermal resistance of a sheet of laminate is not the same as the thermal resistance of a cut part of the laminate.

This value can be determined as a result of the D-5470 test due to its relation with the thermal conductivity below:

### **Thermal Resistance = Thickness / (Thermal Conductivity x Sample area)**

## Thermal Impedance:

- This is the opposite of thermal conductivity. It is a measurement of the ability of a material to oppose the flow of heat. Hence from a PCB side of things, we want this value to be low. The lower the thermal impedance, the quicker heat flows through the PCB and to the heat sink where it is dissipated.
- Its value is dependant on the thermal conductivity of the material and its thickness. Hence, this is not a material property, but is an object property, as changing the thickness of the material will change this value. Saying that, changing the area of the material will not change this value (as long as the thickness stays constant).
- For example: the thermal impedance of a sheet of laminate is the same as the thermal impedance of a cut piece of the laminate, say a cm<sup>2</sup> of it. Whereas the thermal impedance of a sheet of gold of 1mm thickness is different to the thermal impedance of a sheet of 2mm thickness.

This is generally obtained using the D-5470 test mentioned above and relates to the thermal conductivity via the relation:

### **Thermal Impedance = Thickness / Thermal Conductivity**

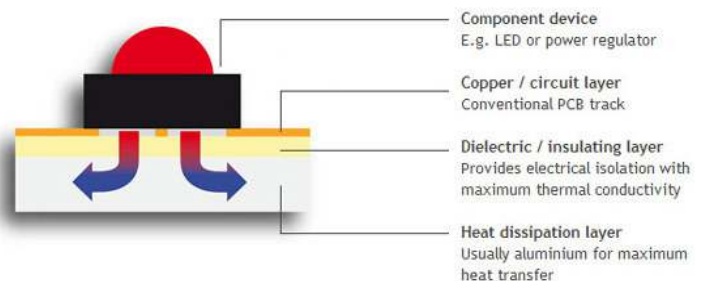

## Other Properties:

Other properties that affect material selection are as follows:

**Dielectric thickness:** Many grades of dielectric come in various thicknesses.

**MOT:** Maximum operating temperature

**Tg:** Glass transition temperature

**Breakdown Voltage:** The voltage at which the material dielectric will break down and short the circuit. As a general rule—the thinner the dielectric, the lower this value will be.

**Peel Strength:** A measurement of the force required to de-laminate the surface copper from the dielectric.

# Designing Thermal Circuits Boards

There are many things to take into consideration when designing circuit boards. Most importantly the design has to be optimal for the purpose of the end product, but at the same time, it needs to be cost effective to reduce the impact on the total cost of the project.

So what things should engineers consider when designing circuits boards?

- Circuit size / shape complexity—what is the yield on a production panel, can it be improved?
- Material selection—are you using the most cost effective option for your application?
- Surface finish— is this the best option for the boards assembly requirements?
- Machining required—can this be optimised?
- Testing—what options are there?

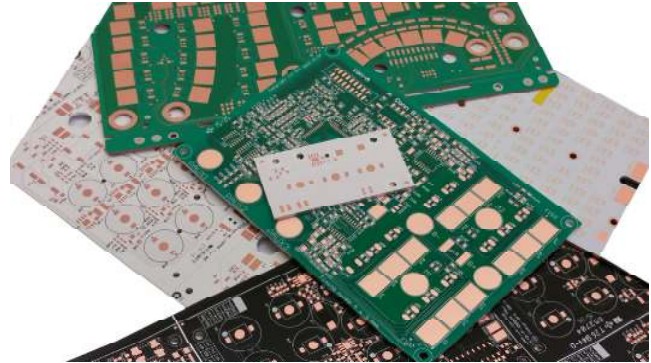

## Circuit Size/Shape—Increase The Yield:

The base material we convert is supplied in standard sizes. Therefore the size/shape of the circuit design has a direct impact on the yield we can get from each production panel. This in turn has a direct affect on the price.

We have two standard sizes:

- ◇ 610 x 457mm (working area 584 x 431mm)
- ◇ 610 x 500mm (working area 584 x 474mm)
- ◇ The working area is based on our tooling system which accounts for a 13mm border each side of the production panel.

Square/rectangular designs are the best for yield due to their simple tessellation.

It is not only the individual circuit shape that has to be considered when designing, but, if specified, the array size as well.

If the size of the array specified at RFQ stage is inefficient we will suggest more cost effective alternatives.

See the representative examples below:

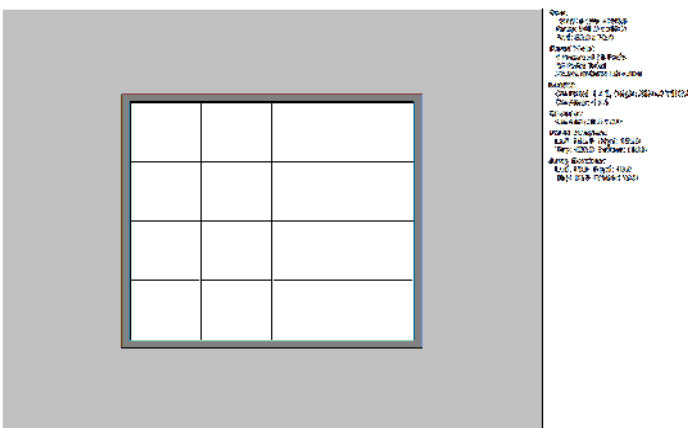

Figure 1—Poor yield

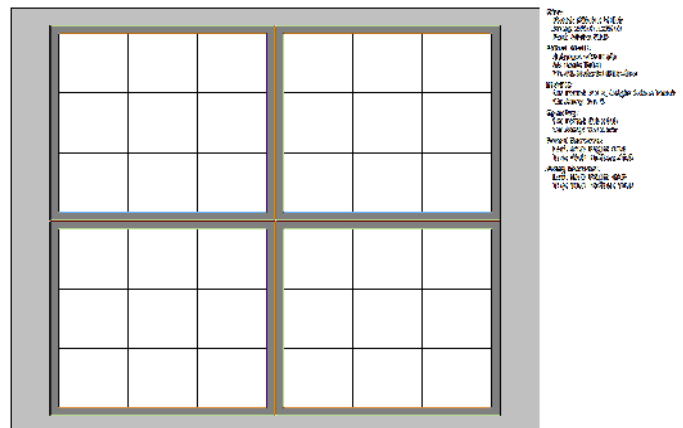

Figure 2—Optimum yield

A customer asks for a 70mm x 80mm board supplied in a 16up array (4 x4) with 10mm scrap bars on all sides.

As you can see from figure 1—this is not very economical at all with less than 34% material utilisation.

At this point we would work out the best yield still in keeping with the customers demand, for example; board size and the customer requirement for scrap bars.

We would then offer up the alternative design to the customer.

As you can see from figure 2 below—if we amend the array design to a 9up (3 x 3), with 10mm scrap bars on all sides, we increase the material utilisation to nearly 75% (a 125% increase on board yield)

This increased yield would have a huge effect on the price of the circuit board.

## Material Selection:

The whole premise of metal circuit technology is based on removing heat from the finished product. This ensures a more efficient unit, as well as increased longevity. It is important therefore to take considerations into the specifications you need the material to meet.

We hold a wide range of stocks from various material manufacturers.

The most common thermal properties considered when specifying materials is the Thermal Conductivity (W/m-K), and the Thermal Impedance ( $^{\circ}\text{C}\text{-cm}^2/\text{W}$ ). These two figures determine how efficient a substrate is at transferring the heat from the components, through the board and onto the heatsink.

General specifications that need to be relayed to us upon enquiry are the board thickness, and the copper weight (most commonly 1.6mm and 2oz respectively).

But further details such as minimum values the board needs to adhere to such as; minimum thermal conductivity, MOT, breakdown voltage and peel strength, will allow us to narrow down the choices available to you.

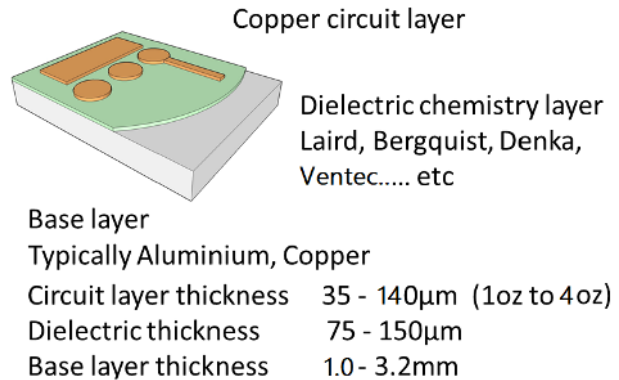

We have vast experience with this technology and if you are unsure of the specifications you require, we can suggest suitable materials based on the application, as well as cost considerations.

Higher grade materials come with a premium—as to be expected.

For this reason it is important not to over spec the requirements of your board as this will lead to using a higher grade material when not required—adding unnecessary cost.

## Surface Finish:

Our most common surface finishes are Lead Free HASL (LF HASL) and Organic Solderability Preservative (OSP) - As such, these are the most cost effective options.

Other, higher cost alternatives are also available such as ENIG, ENEPIG, Immersion Tin and Immersion Silver

OSP Advantages	OSP Disadvantages
Excellent flatness	Sensitive to handling—measures must be taken into avoid scratches
Great for fine tracks/small pads	Limited thermal cycles (>2/3) and limited shelf life.
Relatively low cost	Difficult to inspect
Suitable for re-work	Short operating window
Clean, environmentally friendly process	Solder paste rework can have negative effect on the OSP coating
	Relatively short shelf life of

LF HASL Advantages	LF HASL Disadvantages
Excellent solderability and relative low cost	Causes a difference in thickness/topography between pads
Multiple thermal paths	Not suited for <20mil pitch SMD & BGA
Allows for a large processing window	May cause bridging on fine tracks
Well known finish—lots of industry experience	Not ideal for HDI Products
Long shelf life >12 months	

The main factors for consideration when specifying surface finish are; the application of the end product, the assembly method used to populate the boards, and the overall design of the PCB itself.

Each option has its pro's and cons—and these will determine their suitability to your application.

## Machining / Fabrication:

**Scoring:** The most common process for square/rectangular shapes. Suitable for both low and high volume, often carried out prior to punching with high volume production batches. This method also allows the best yield per production panel as no spacing is required between circuits—meaning less waste/lower cost. Scoring also allows for easy separation of boards as opposed to some routed circuit designs.

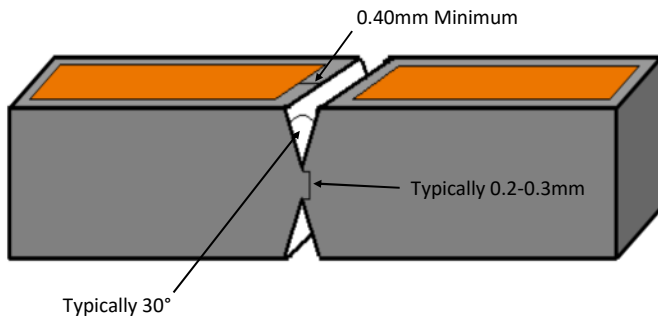

**Drilling/routing:** For low/volume orders each production panel is drilled and/or routed (according to design requirements). Routing boards is slow and costly, but if an irregular shape is required then this is a necessary process.

**Punching:** For high volume orders the holes, as well as the shape of the PCB can be achieved by using a press machine loaded with a bespoke made tool. This greatly reduces the time taken to fabricate the production panels into finished boards. It allows for repeatability and generally accounts for less variation per batch than routing. Of course this does come with the premium of high tooling costs—but if the numbers are high enough this can be insignificant to the project—especially when compared to machining.

---

## Testing:

One of the last processes in the production cycle is testing. This ensures that each board we produce is functioning as it should do.

Some customers do not require us to carry out this process and as such the cost of the completed circuit board will be less. However, in the vast majority of cases this process is recommended. It can be very costly to populate a faulty board and not find out until later on.

### **Electrical:**

This is the standard test carried out to make sure that the circuitry is functioning as it should be. Making sure that all required connections are complete. If there are any shorts within the track work, this will be shown up on the test.

A simple Pass/Fail test that allows us to quickly separate out the good from the bad.

### **Hi-Pot:**

An additional test option is available on request. This is called a Hi-Pot test—it is designed to test the breakdown voltage of the finished board.

The breakdown voltage is the voltage at which the electrically insulating dielectric will no longer be able to withstand the electrical attraction between the current running through the copper circuitry, and the aluminium base material. If this voltage is reached the dielectric will 'break' and the board will short circuit.

With high voltage applications this test is carried out to make sure that the dielectric can withstand the voltages that it will be subjected to.

It may also be a critical requirement for any boards that will be used in safety critical environments

